

LAME ALUMINIUM LARGEUR 200
200 mm BLADE ALUMINIUM

LAME ALUMINIUM LARGEUR 150
150 mm BLADE ALUMINIUM

LAME ALUMINIUM LARGEUR 100
100 mm BLADE ALUMINIUM

LAME COMPACT SUR SUPPORT LAME PF100
HPL Laminate blade on PF100

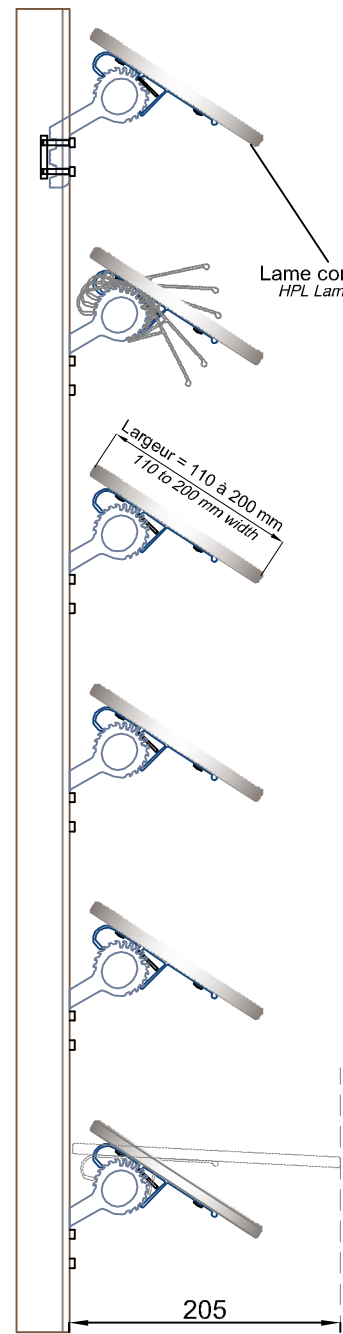
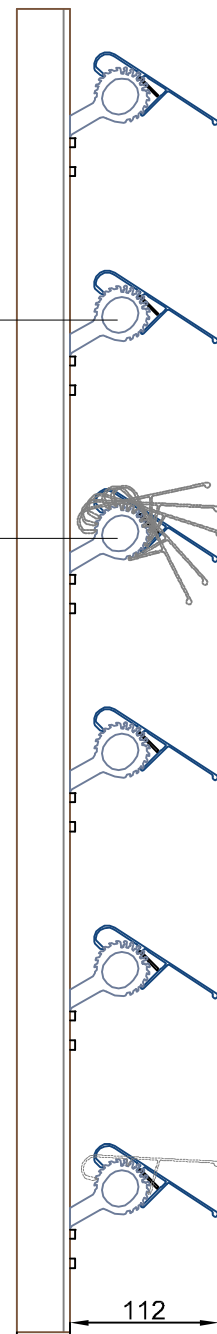
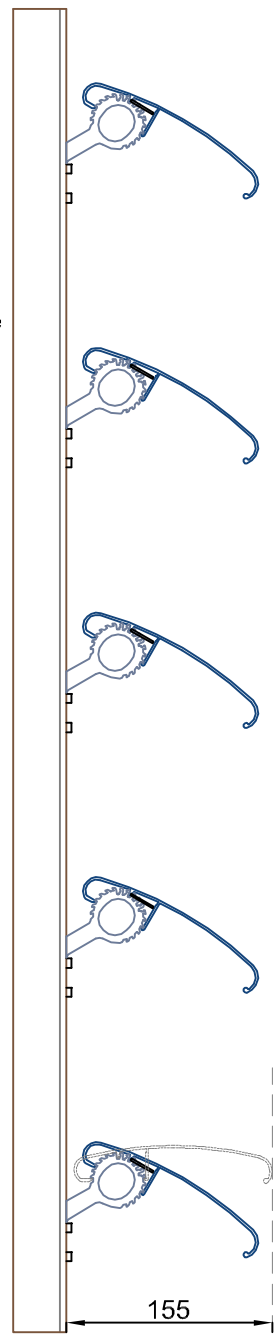
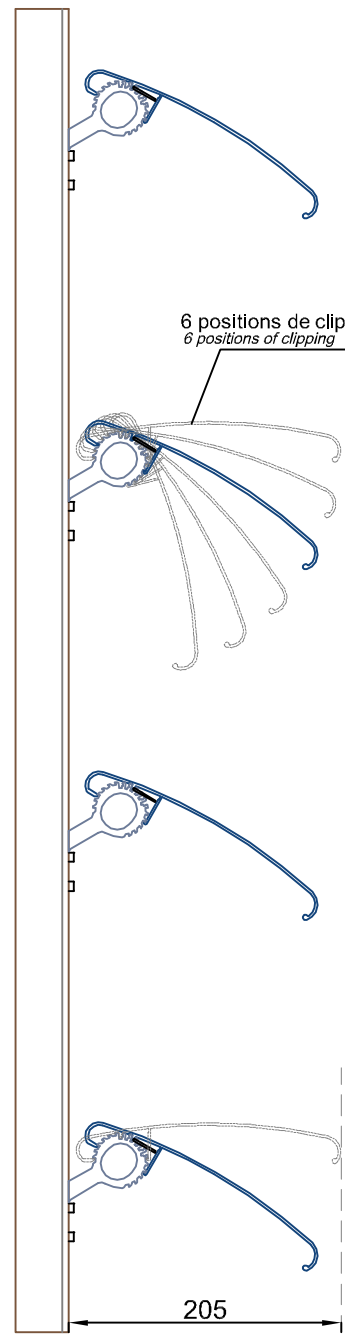

VERSION CASQUETTE LAME COMPACT
PROJECTION VERSION WITH HPL LAMINATE BLADES

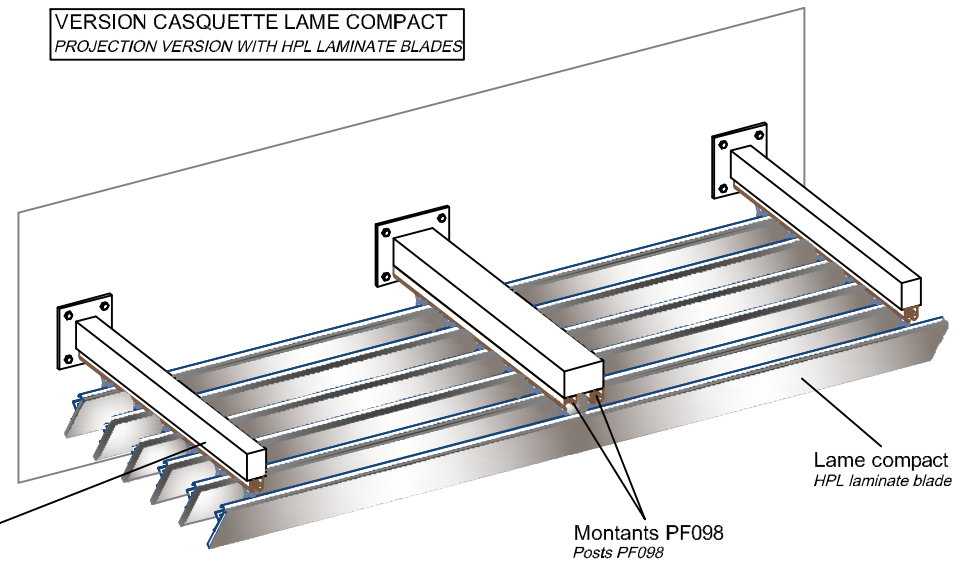

Attention! Les lames compact doivent être fixées suivant les normes et recommandations propres au fabricant de compact.

VERSION BRISE SOLEIL A FACETTES LAME COMPACT
FACETS VERSION WITH HPL LAMINATE BLADES

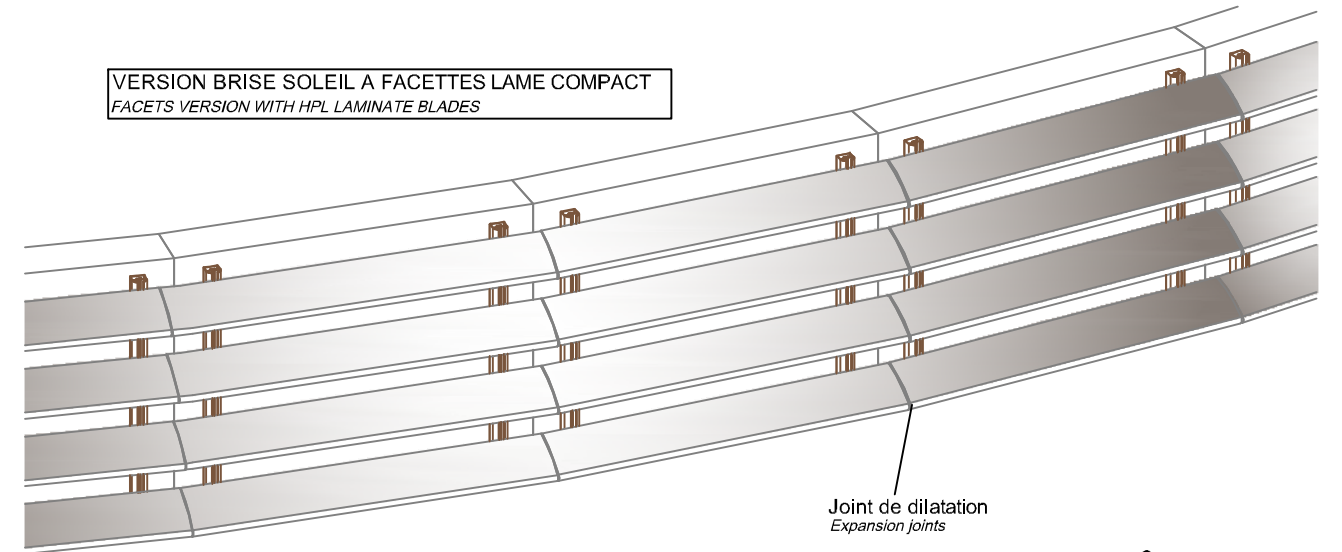

VERSION BRISE SOLEIL FACADE LAME COMPACT
FACADE VERSION WITH HPL LAMINATE BLADES

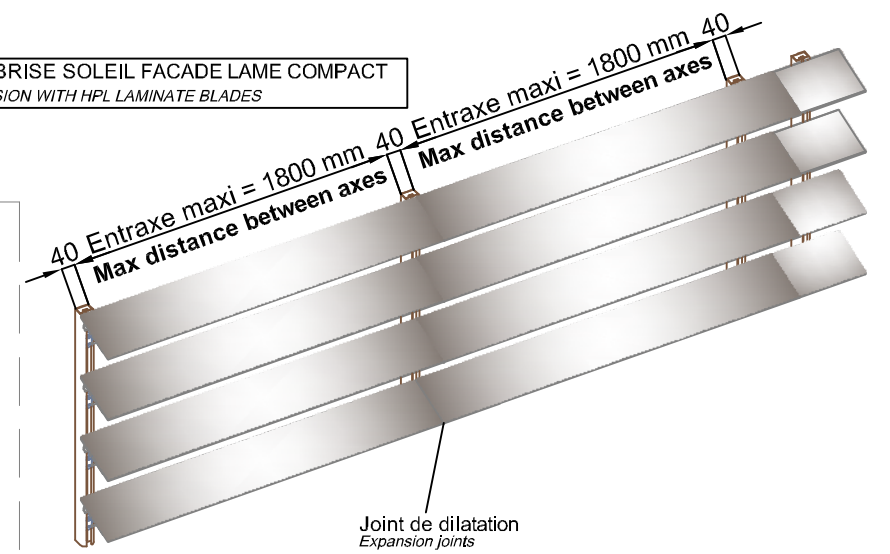

PIECES ACCROCHES LAME ALU
ALUMINIUM BLADE CONNECTING PIECES

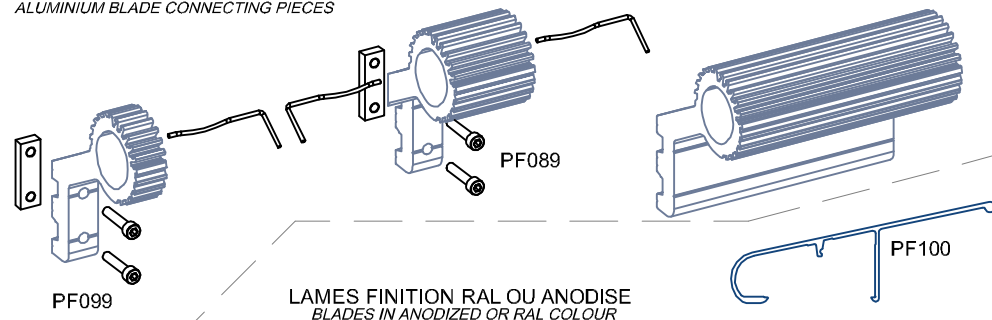

LAMES FINITION RAL OU ANODISE
BLADES IN ANODIZED OR RAL COLOUR

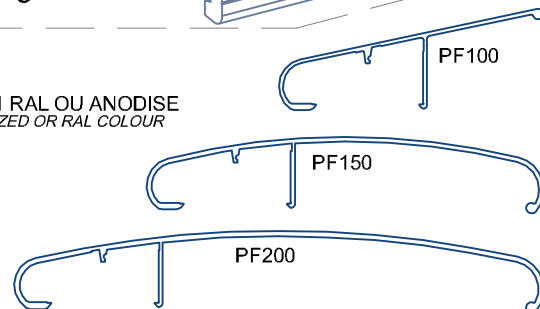

Montant PF098
PF098 Post



Lame compact
HPL laminate blade

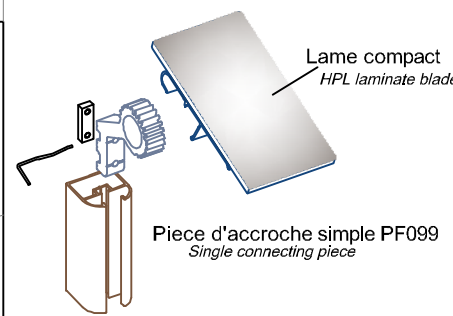

Pièce d'accroche double PF089
Double connecting piece PF089

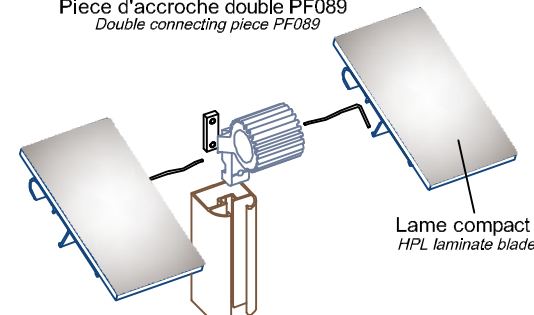

Lame compact
HPL laminate blade

Version structure porteuse (non fournie)
Support structure version (not supplied)

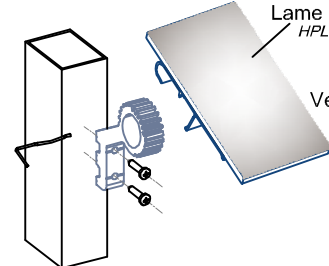

EVERGLADE
Compact / HPL Laminate

PRINCIPE / PRINCIPLE

Réf.: PFEV-PP1-A34ind1 Date: 01/09/08

Echelle: - Dessin: BX

10



COMMERCIAL / USINE

Tél.: +33 (0)2 37 90 46 46
Fax: +33 (0)2 37 90 20 10

Mail: info@sab-inter.com
Site: www.sab-inter.com



EVERGLADE *COMPACT*

BRISE SOLEIL

- Nom Commercial EVERGLADE
- Type de montage
 - Horizontal
 - Vertical
 - Projection
- Type de pose
 - Fixe
- Type de lame
 - Lame Aluminium plate

- Réf. PF100 permettant de recevoir des lames compact ou bois

- Fixation des lames

Les lames compact doivent être fixées suivant les normes et les recommandations propres au fabricant de compact

Support en aluminium extrudé comprenant 6 positions d'orientation
Réf. PF099 et PF089 + axe de verrouillage de sécurité en inox

- Montant

Réf. PF098

Profil extrudé en 40x40 avec gorge et cage pour recevoir les supports permettant de faire le réglage à l'entraxe souhaité, à fixer sur la structure porteuse

- Essais au vent Rapport SOCOTEC  pour des vents de 260km/h
- Aluminium 6060 T5
- Finition Thermo laquage
Anodisé 20 microns

SAB INTERNATIONAL
Service commercial / Usine
ZA Croix Saint Mathieu, 28320 GALLARDON, France
☎ 02 37 90 46 46 Fax : 02 37 90 20 10
Site : www.sab-inter.com / e-mail : contact@sab-inter.com



EVERGLADE *HPL LAMINATE*

SOLAR SHADING

- Commercial name EVERGLADE
- Type of installation
 - Horizontal
 - Vertical
 - Projection
- Type of setting
 - Fixed
- Type of blade
 - Flat aluminium blade

- Ref. PF100 can receive HPL Laminate or timber blade

- Fixing of the blades

The HPL Laminate blade must be fixed according to the standards and the advices of the HPL Laminate manufacturer.

Extruded aluminium support with 6 positions of inclination
Ref.PF099 and PF089 + stainless steel security locking

- Post

Ref. PF098

40x40 extruded profile with groove and cage to receive the supports in order to adjust at the adjustable distance between axes, to fix on the support structure

- Wind tests SOCOTEC report  for 260 km/h winds
- Aluminium 6060 T5
- Finishing Thermo lacquering
20 microns anodised

SAB INTERNATIONAL
Exports Dept. / Factory
ZA Croix Saint Mathieu, 28320 GALLARDON, France
☎ +33 2 37 90 46 46 Fax : +33 2 37 90 20 10
Website : www.sab-inter.com / e-mail : info@sab-inter.com